

Renal cell carcinoma

all genes

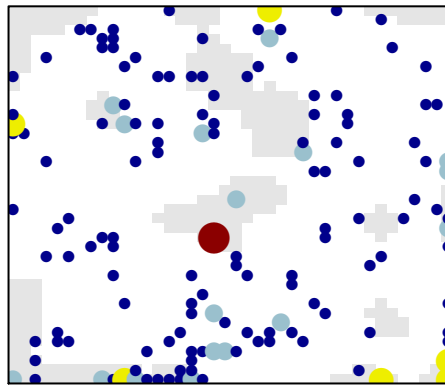

sink node genes

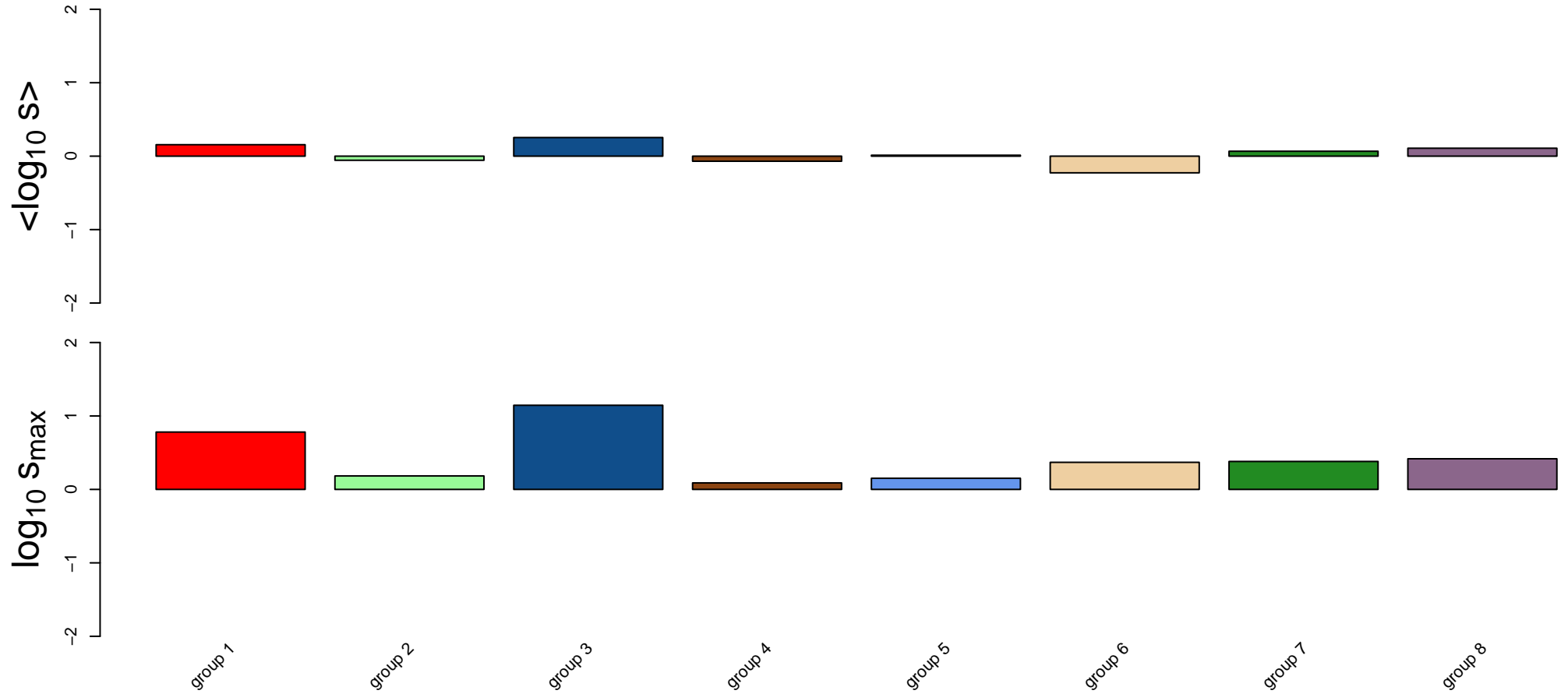
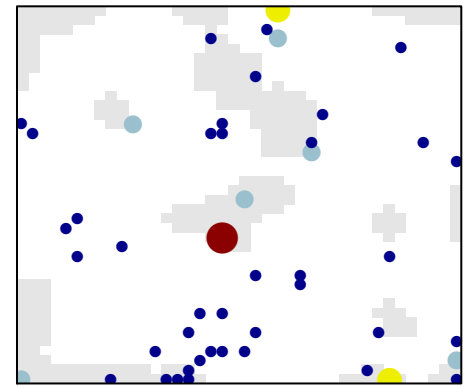

Renal_cell_carcinoma genes with data

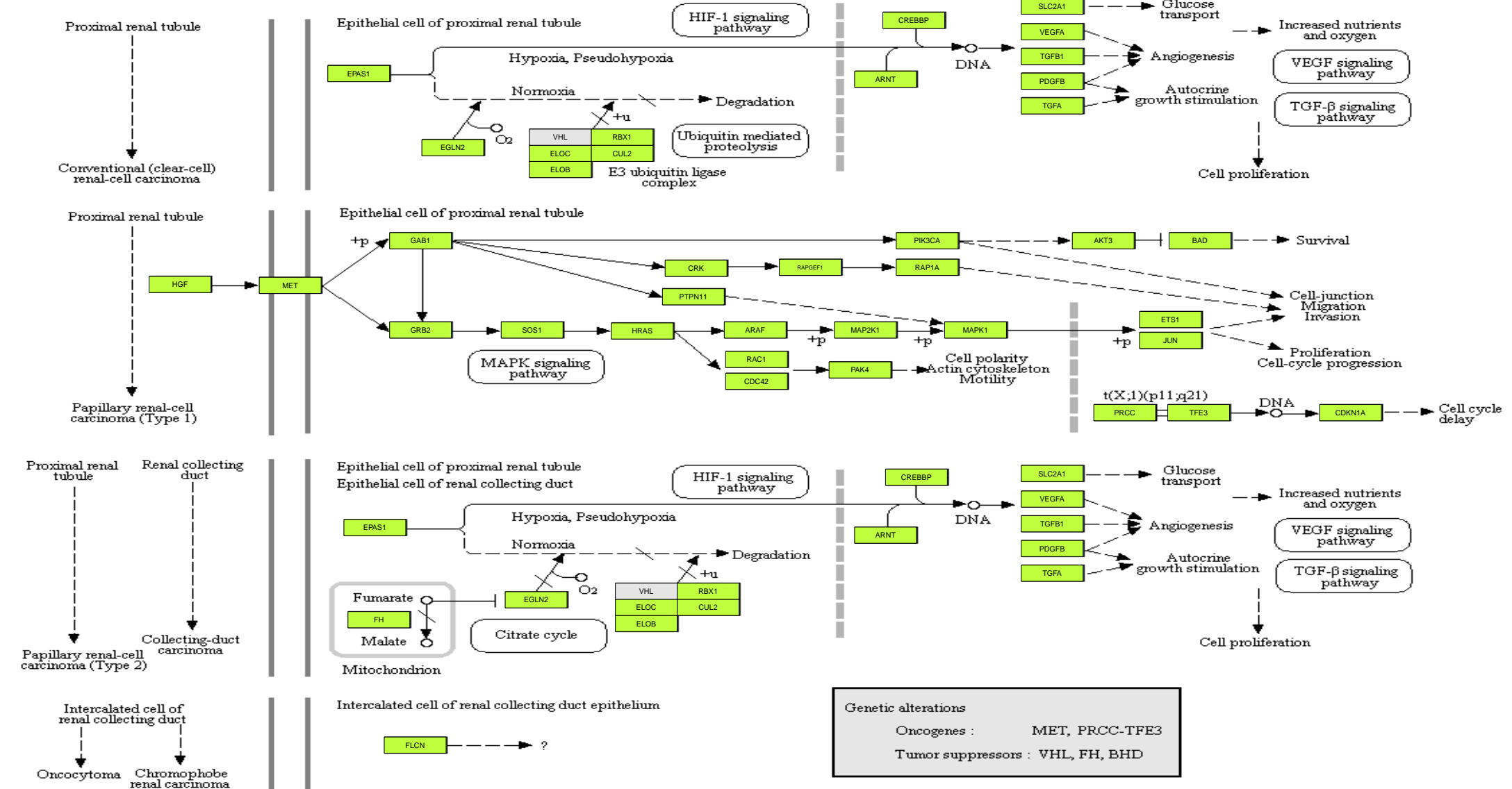

Genetic alterations

Oncogenes : MET, PRCC-TFE3

Tumor suppressors : VHL, FH, BHD

Renal_cell_carcinoma sink nodes

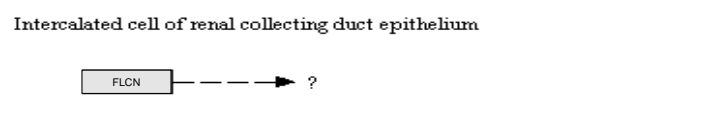
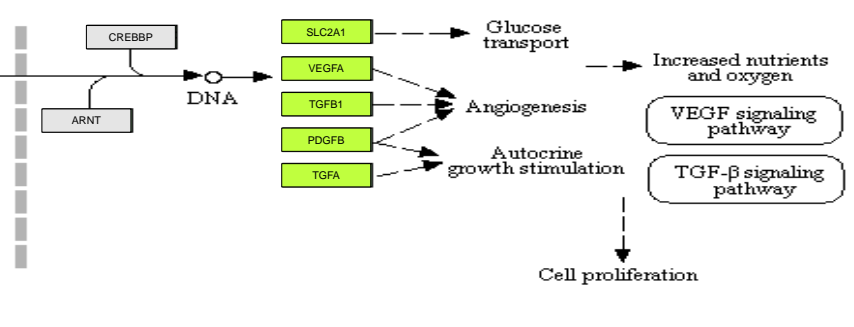
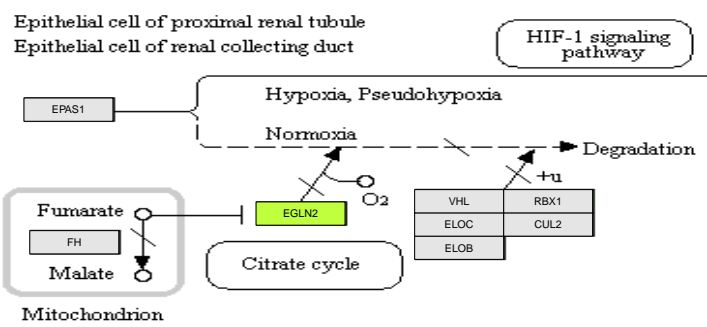
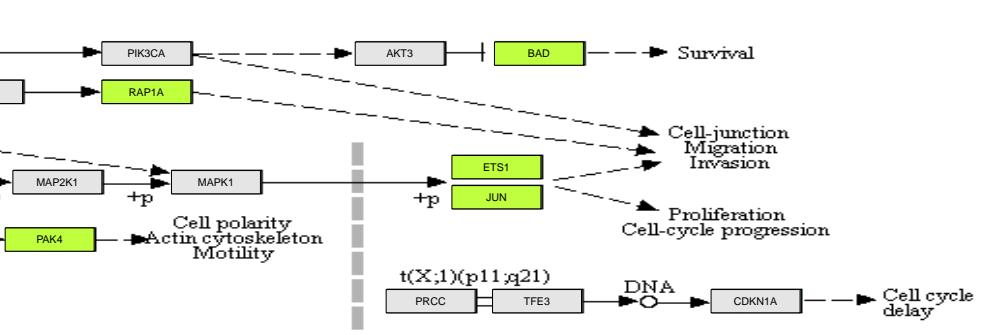
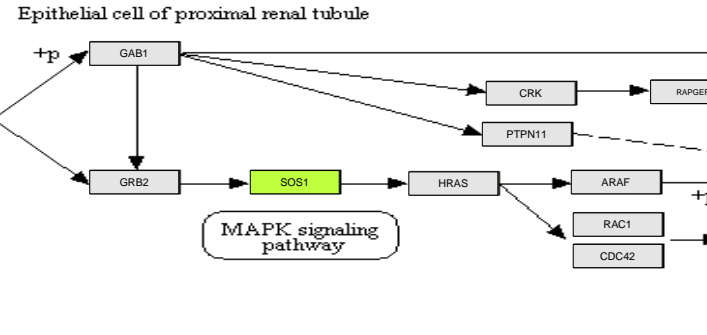
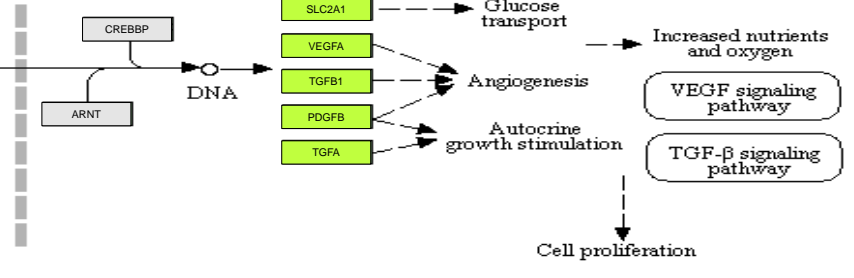
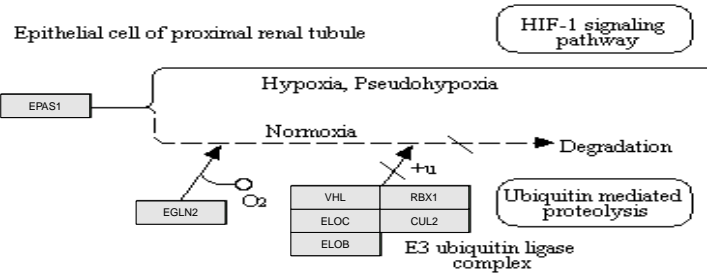
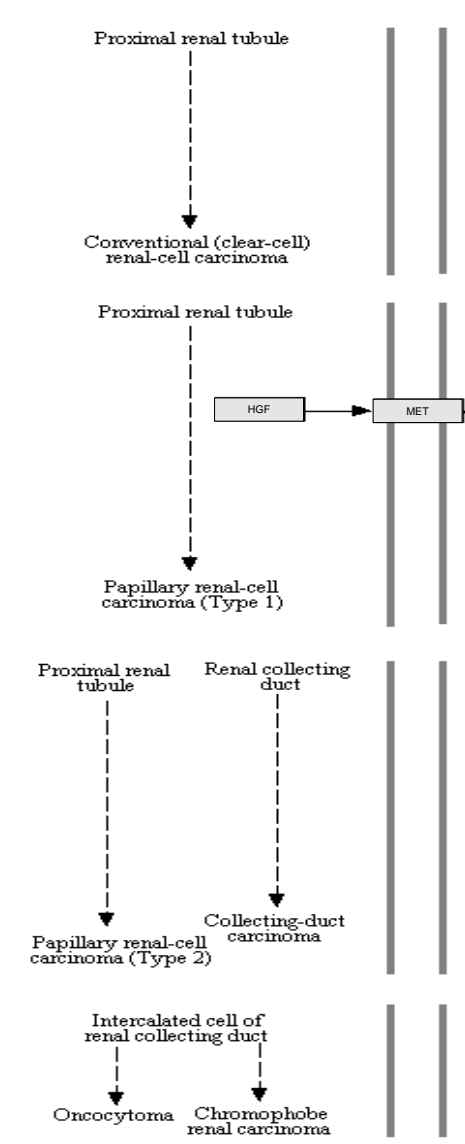

Genetic alterations

Oncogenes : MET, PRCC-TFE3

Tumor suppressors : VHL, FH, BHD

Renal_cell_carcinoma group 1

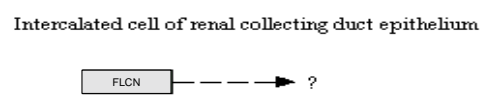
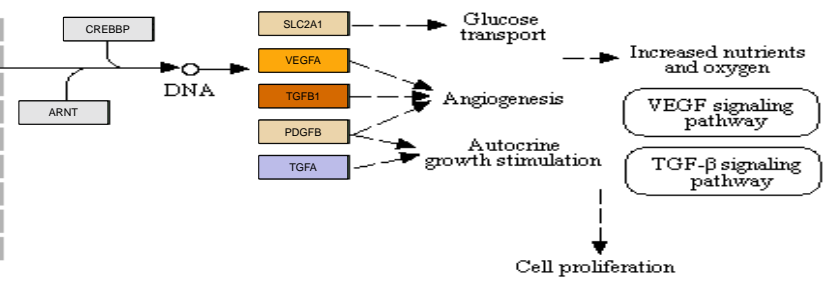
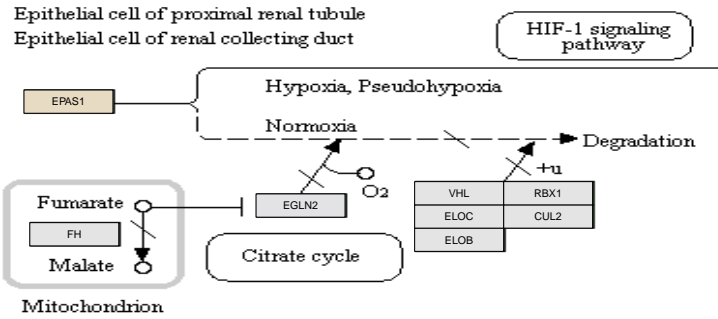
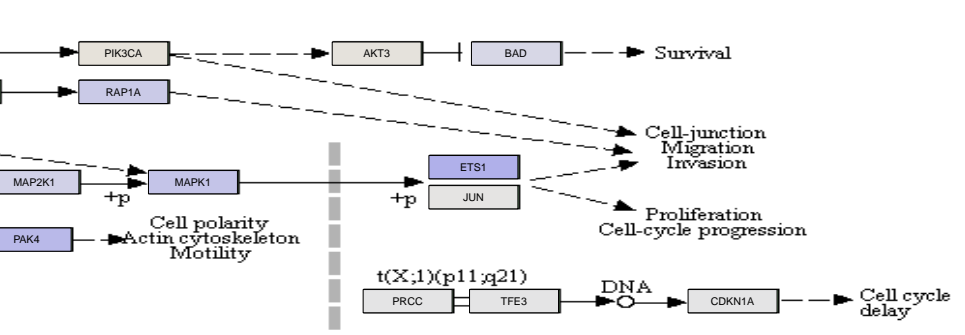
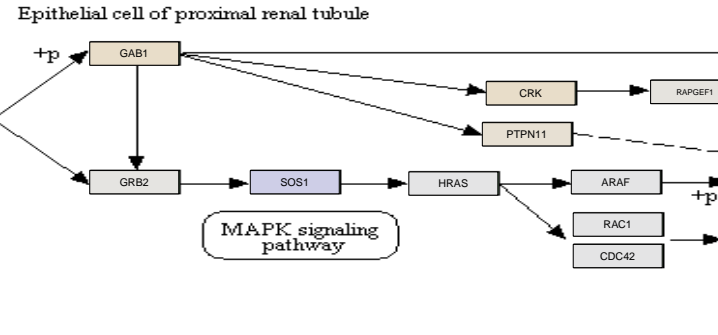
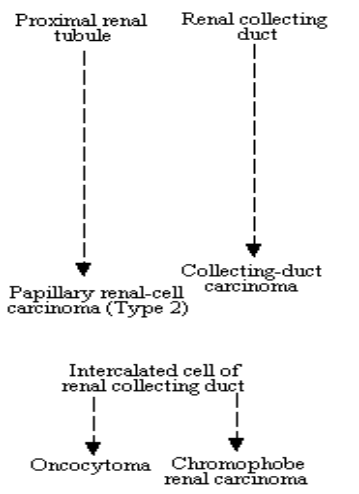
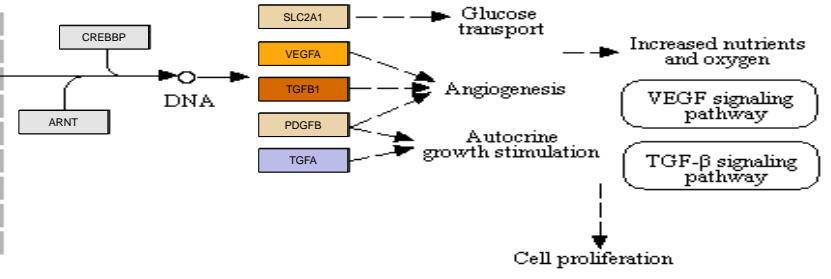
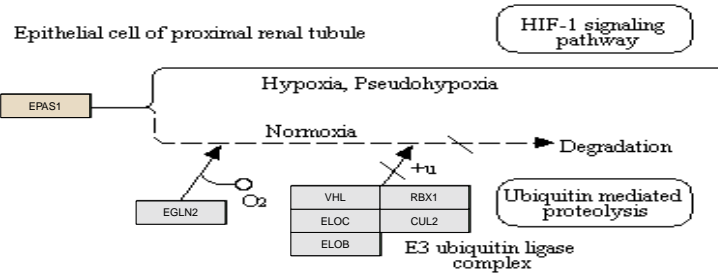
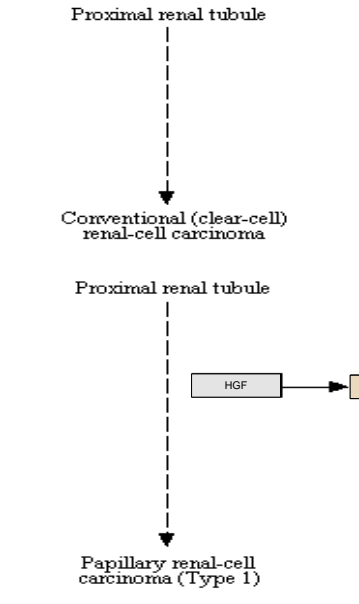

Genetic alterations
 Oncogenes : MET, PRCC-TFE3
 Tumor suppressors : VHL, FH, BHD

Renal_cell_carcinoma group 2

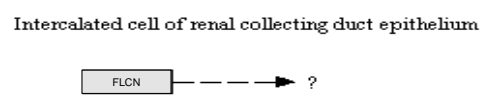
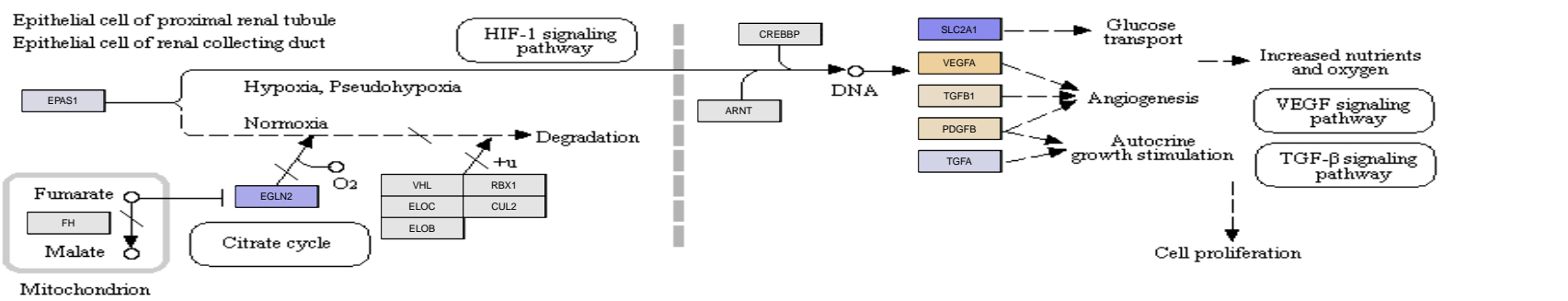
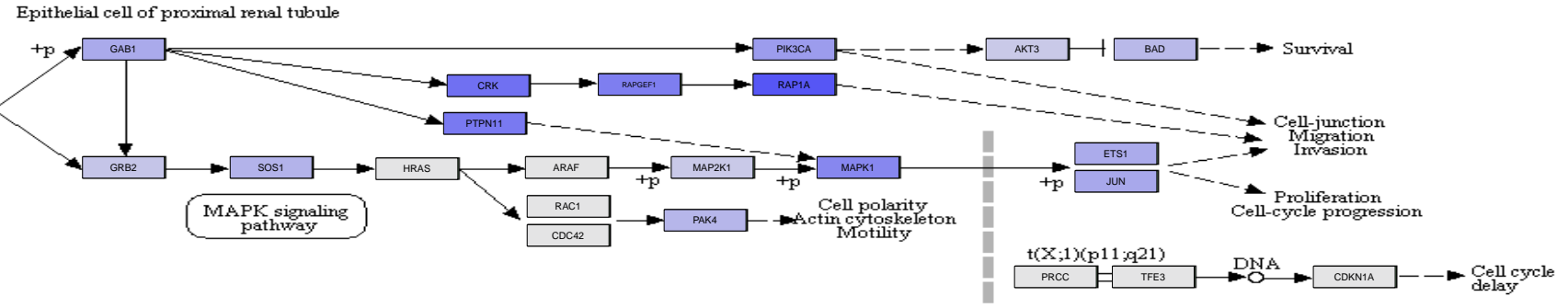
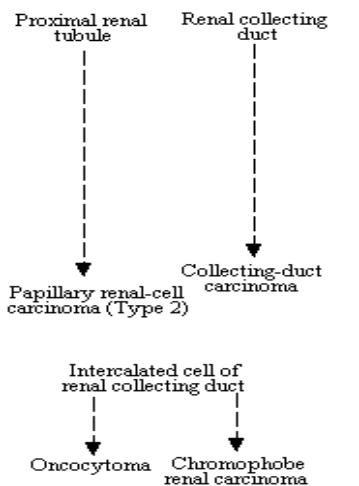
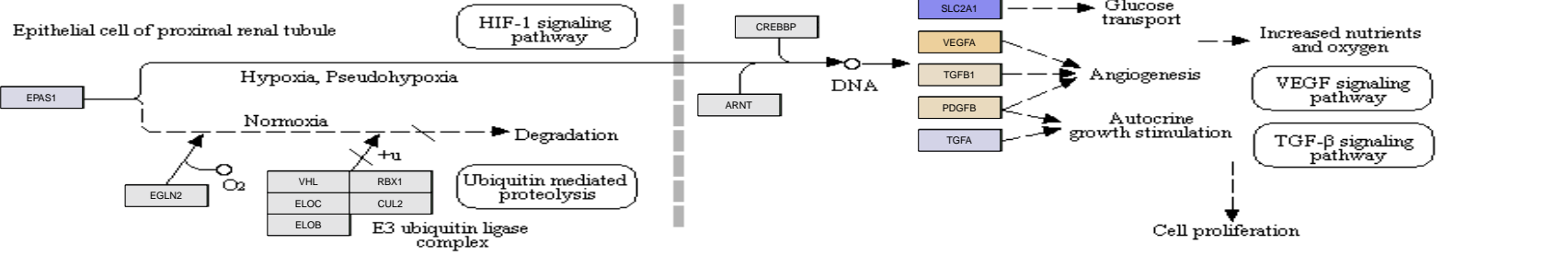
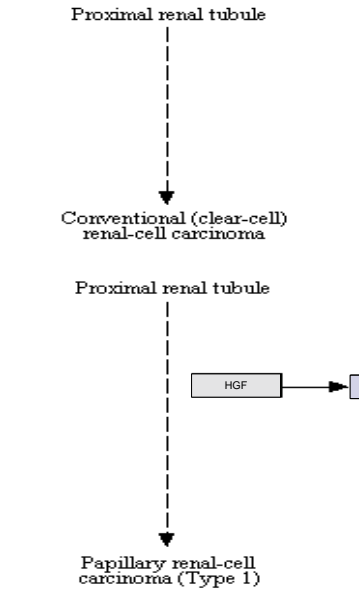

Genetic alterations
 Oncogenes : MET, PRCC-TFE3
 Tumor suppressors : VHL, FH, BHD

Renal_cell_carcinoma group 3

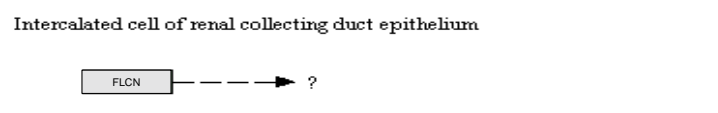
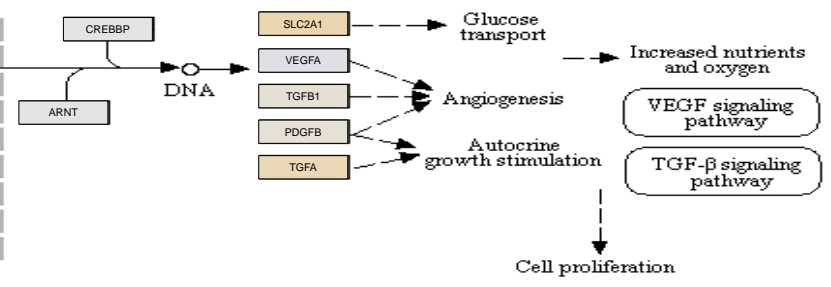
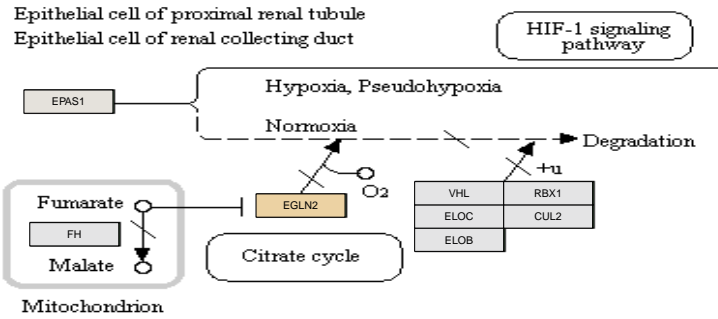
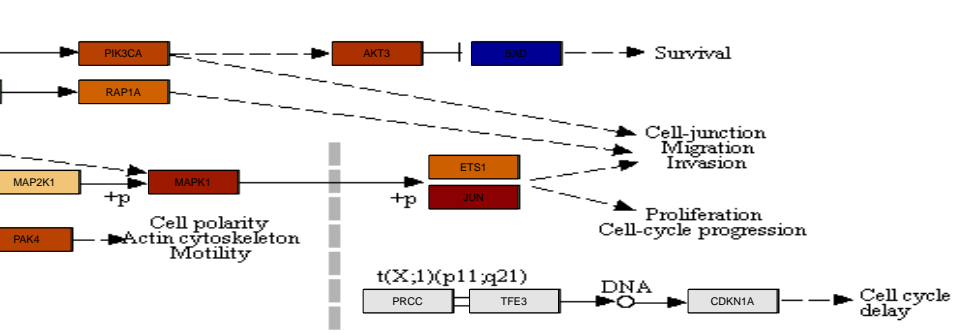
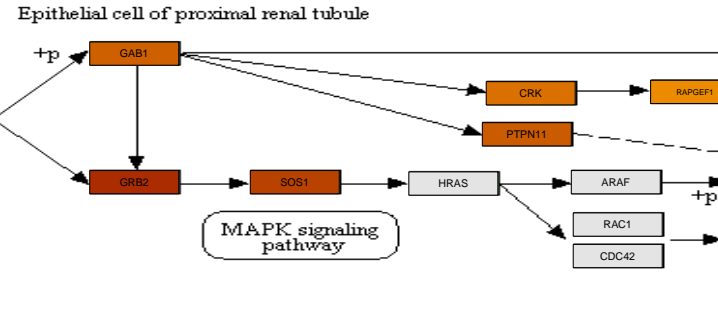
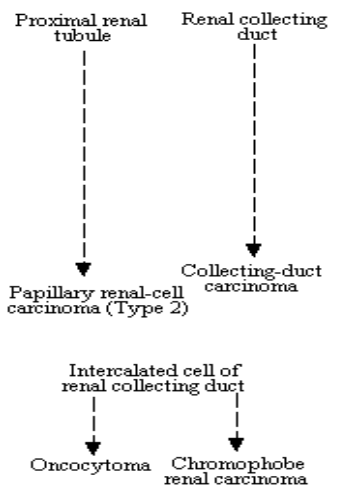
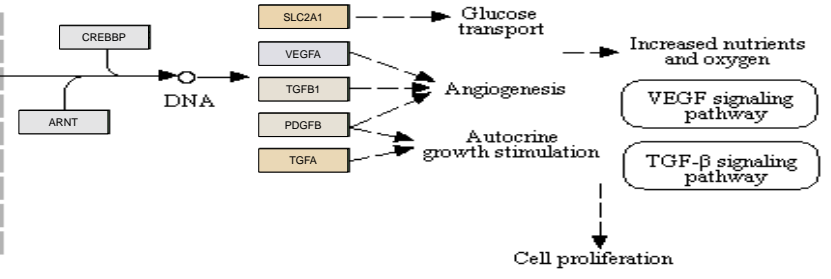
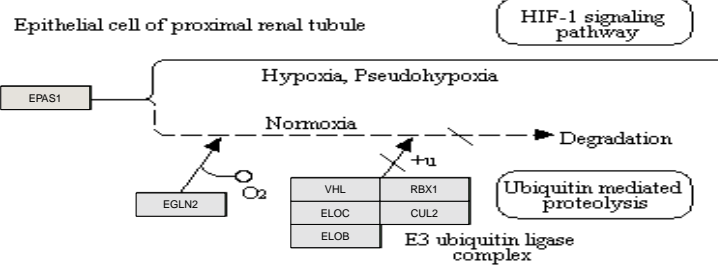
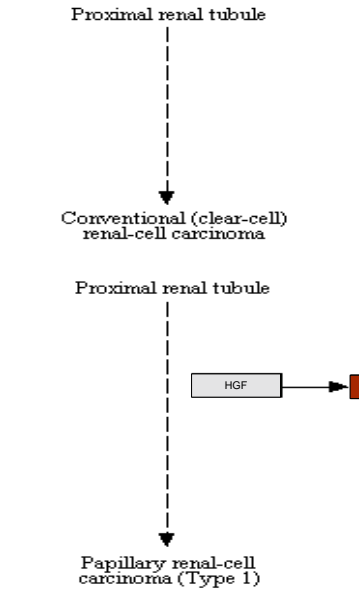

Genetic alterations
 Oncogenes : MET, PRCC-TFE3
 Tumor suppressors : VHL, FH, BHD

Renal_cell_carcinoma group 4

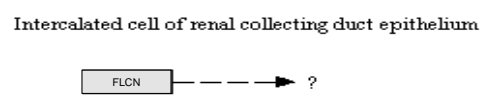
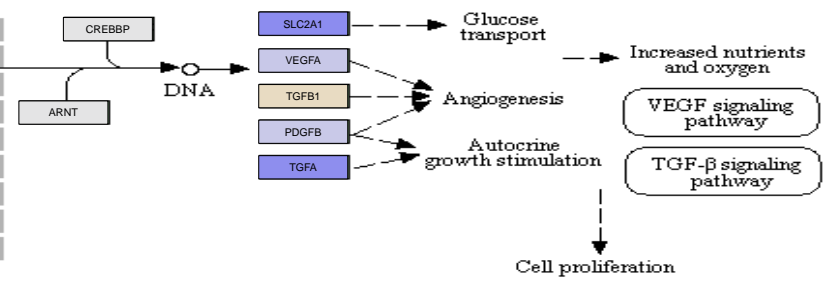
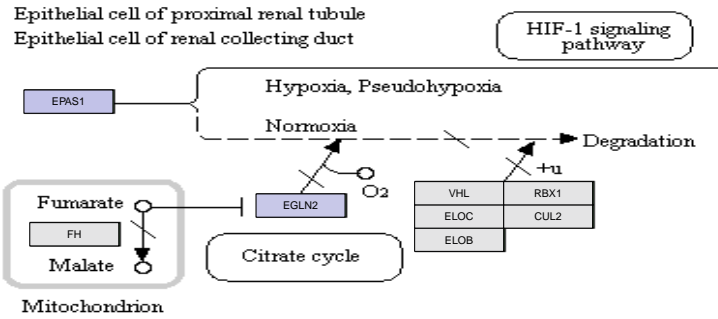
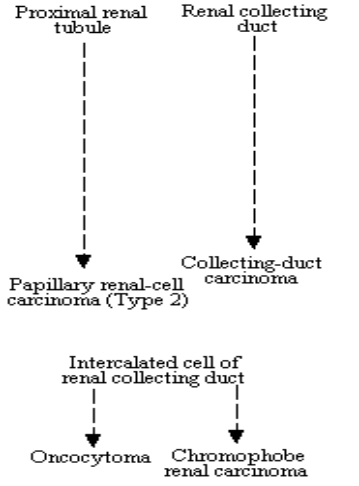
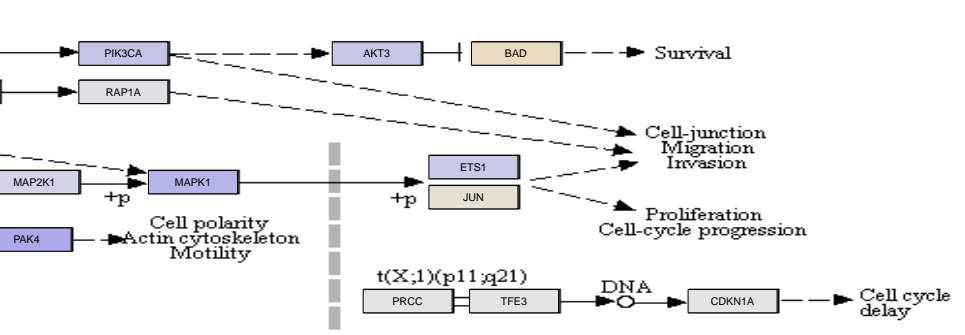
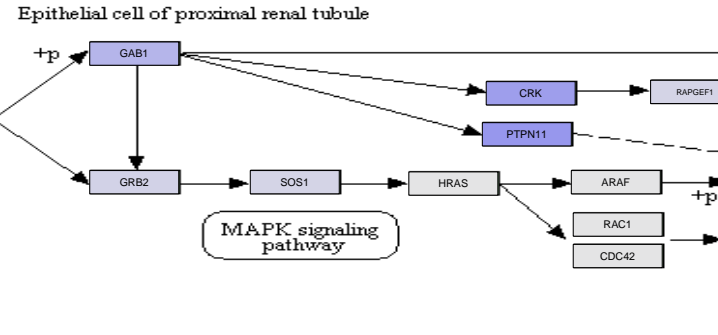
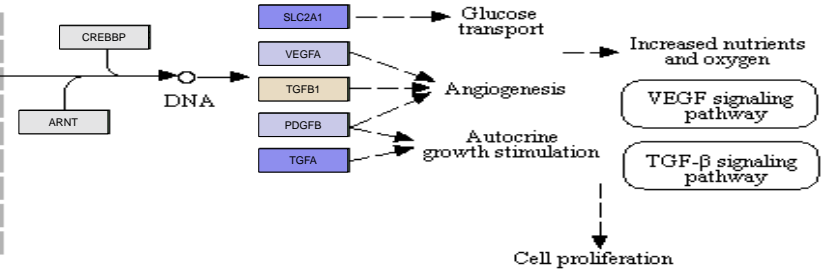
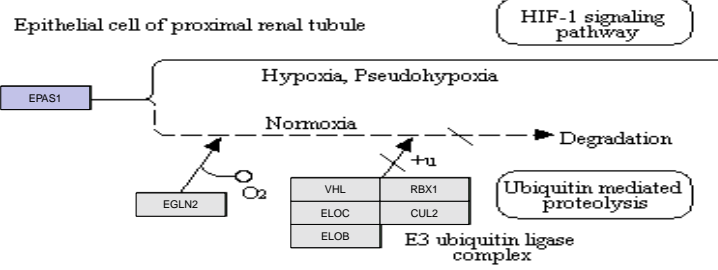
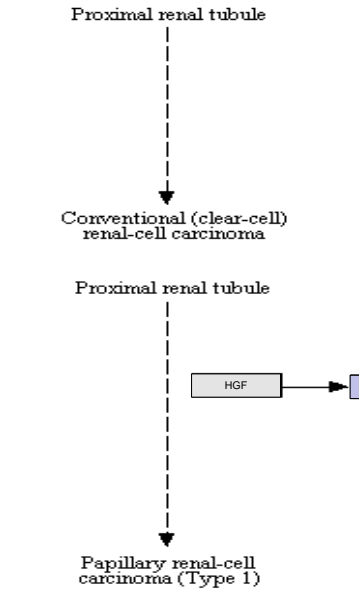

Genetic alterations
 Oncogenes : MET, PRCC-TFE3
 Tumor suppressors : VHL, FH, BHD

Renal_cell_carcinoma group 5

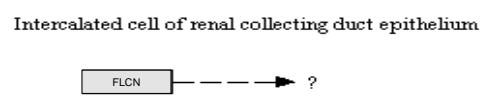
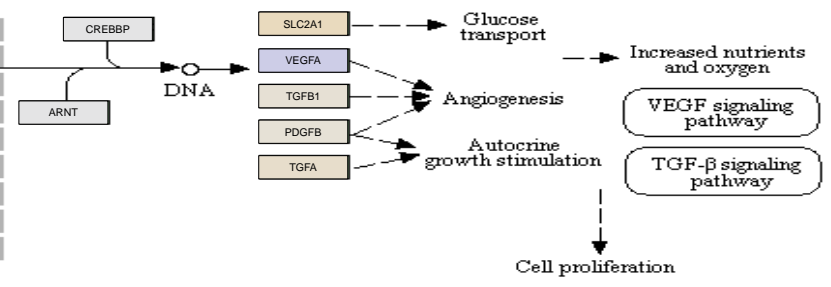
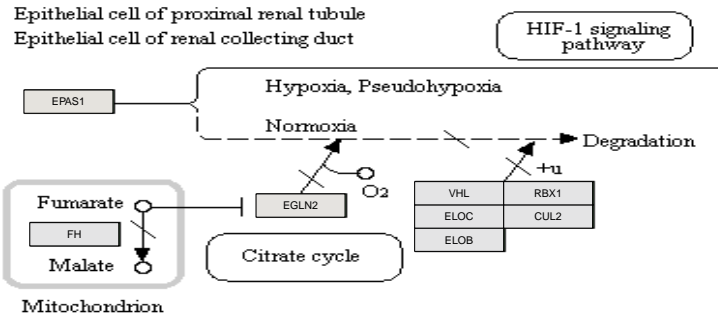
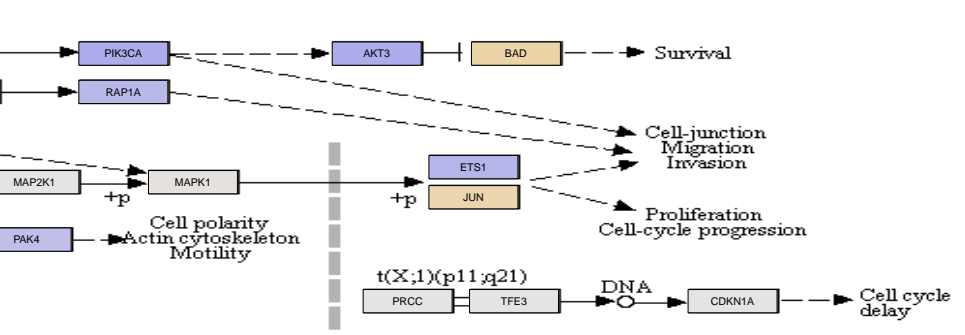
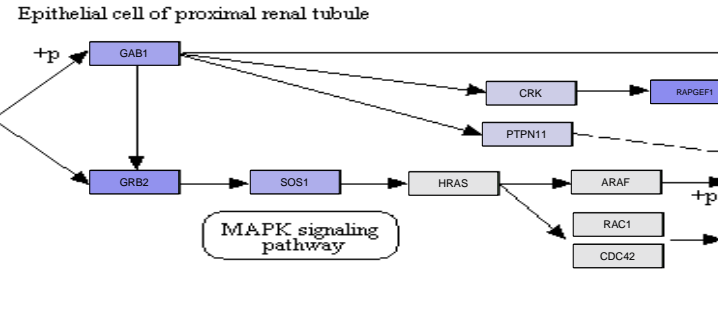
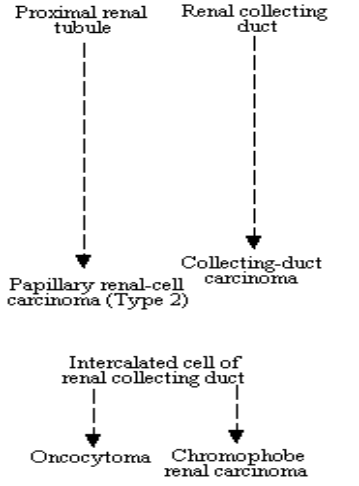
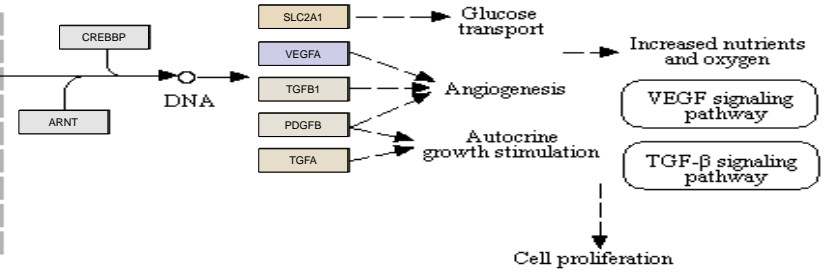
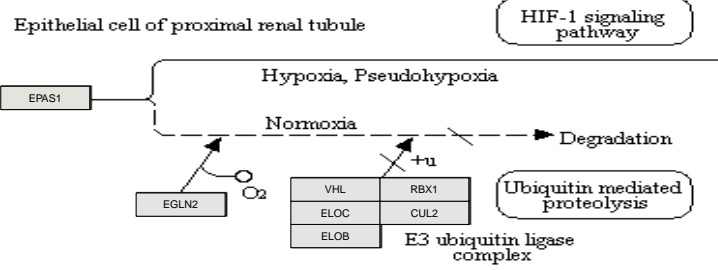
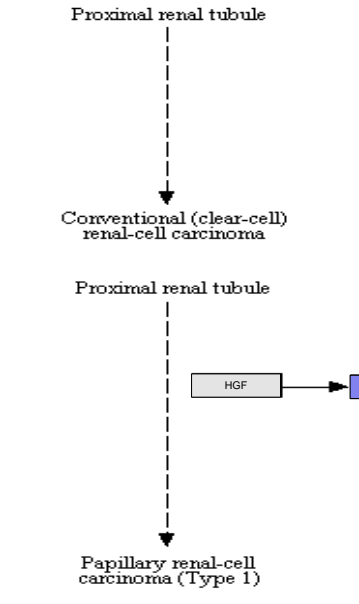

Genetic alterations
 Oncogenes : MET, PRCC-TFE3
 Tumor suppressors : VHL, FH, BHD

Renal_cell_carcinoma group 6

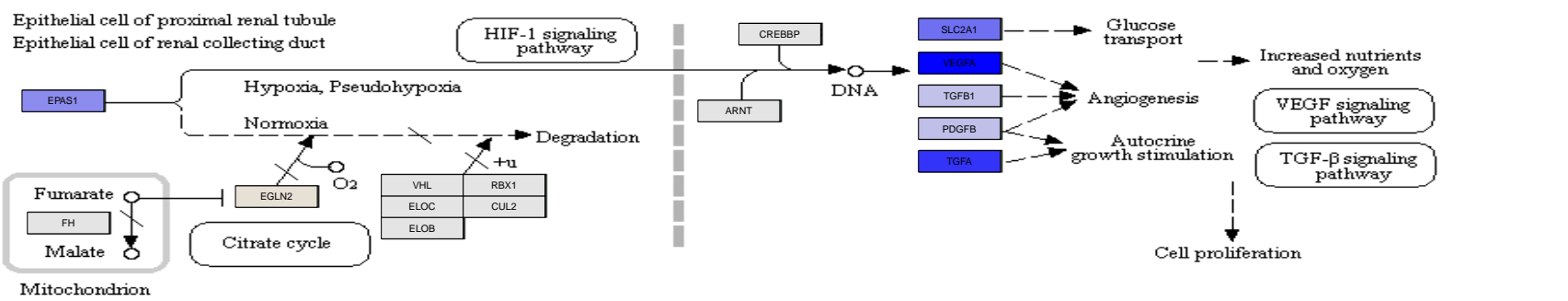
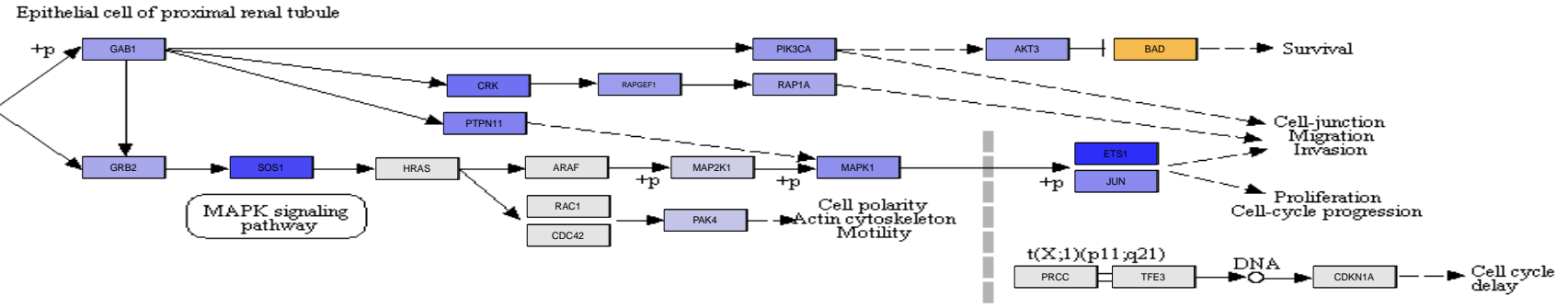
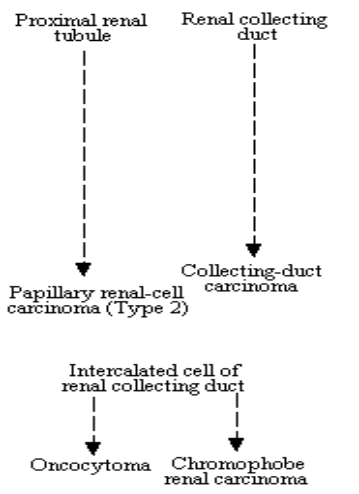
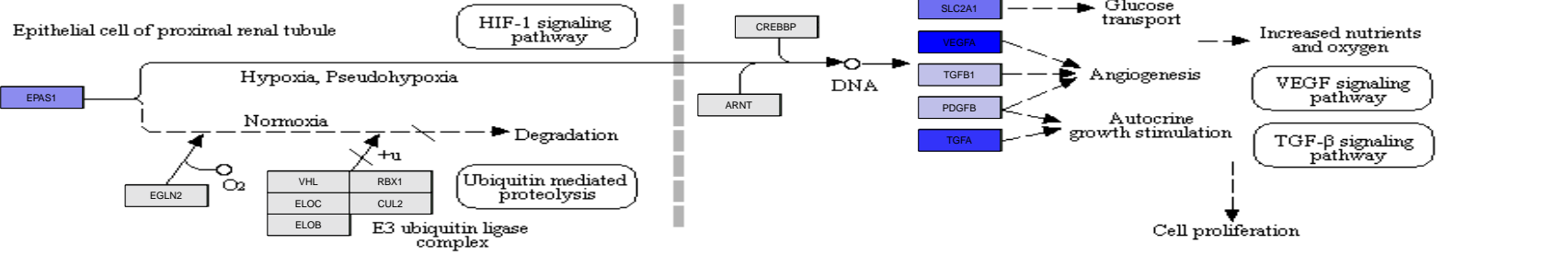
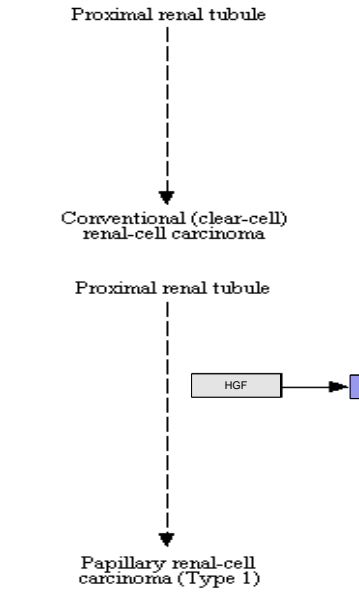

Renal_cell_carcinoma group 7

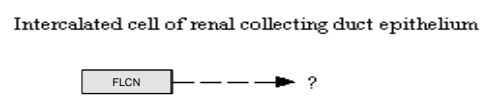
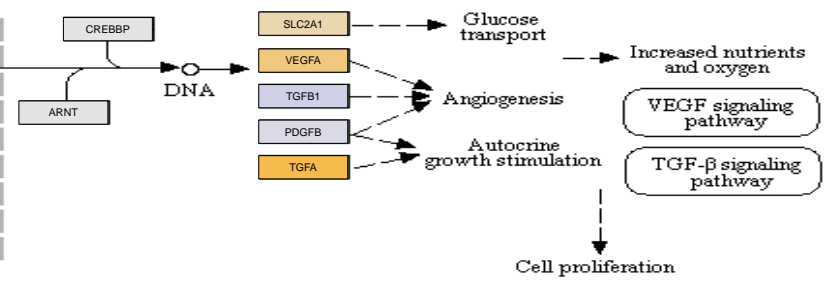
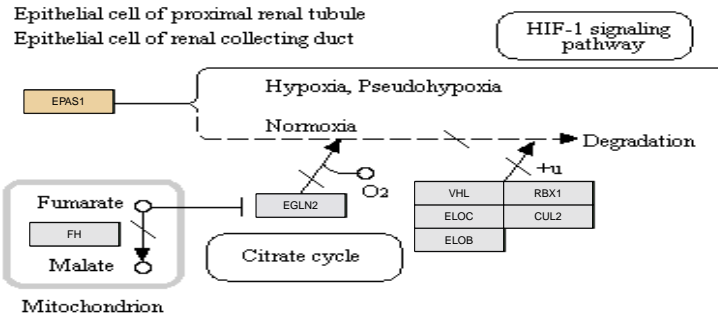
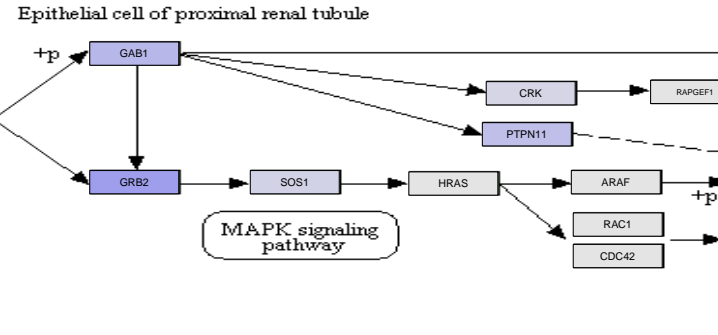
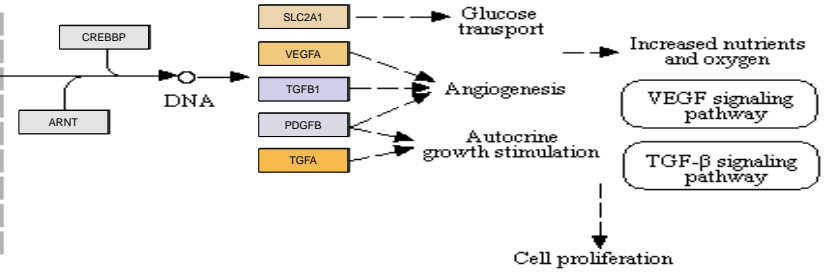
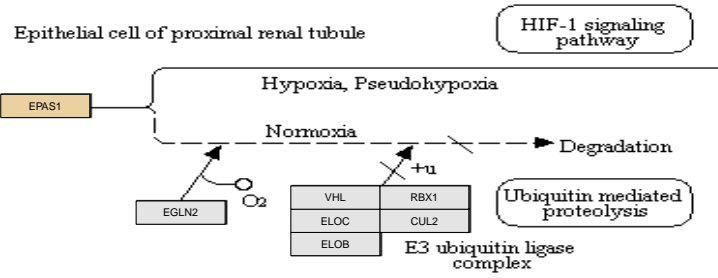
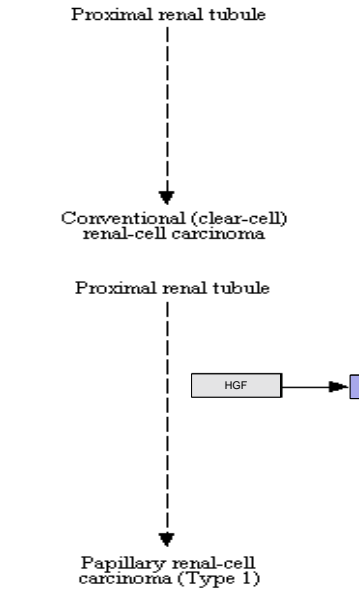

Genetic alterations

Oncogenes : MET, PRCC-TFE3

Tumor suppressors : VHL, FH, BHD

Renal_cell_carcinoma group 8

Proximal renal tubule
 ↓
 Conventional (clear-cell) renal-cell carcinoma

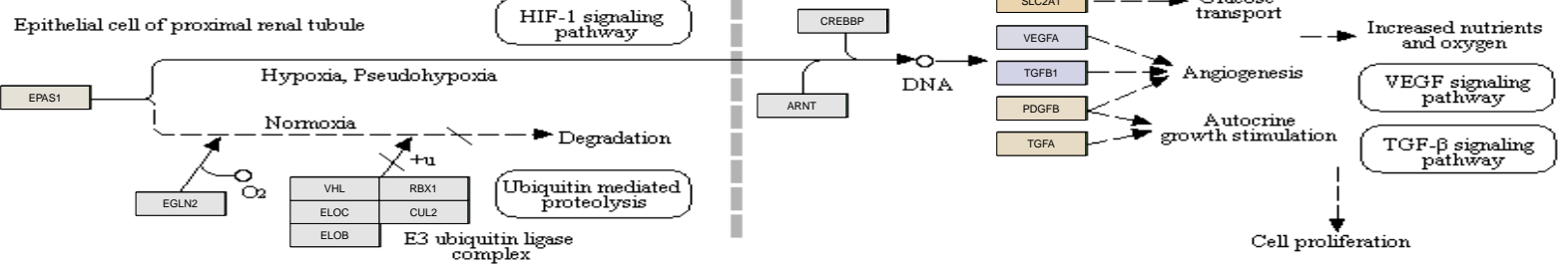

Proximal renal tubule
 ↓
 Papillary renal-cell carcinoma (Type 1)

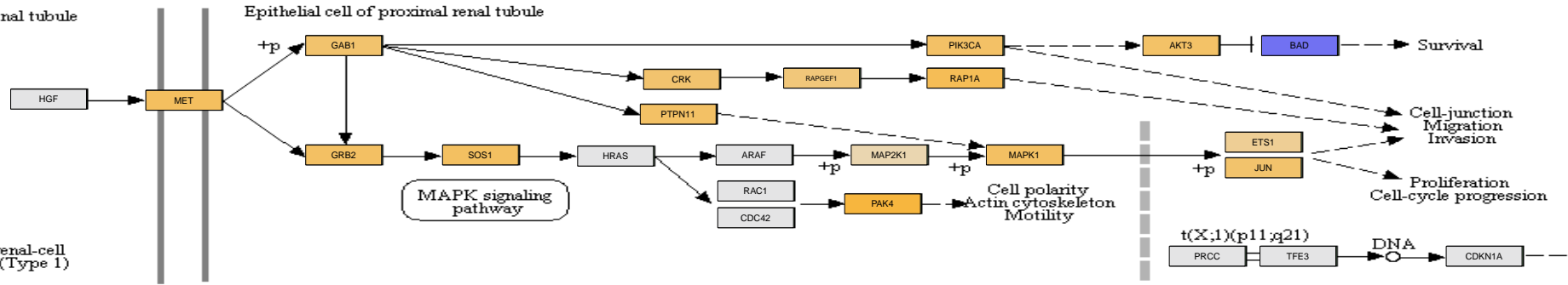

Proximal renal tubule
 ↓
 Papillary renal-cell carcinoma (Type 2)

Renal collecting duct
 ↓
 Collecting-duct carcinoma

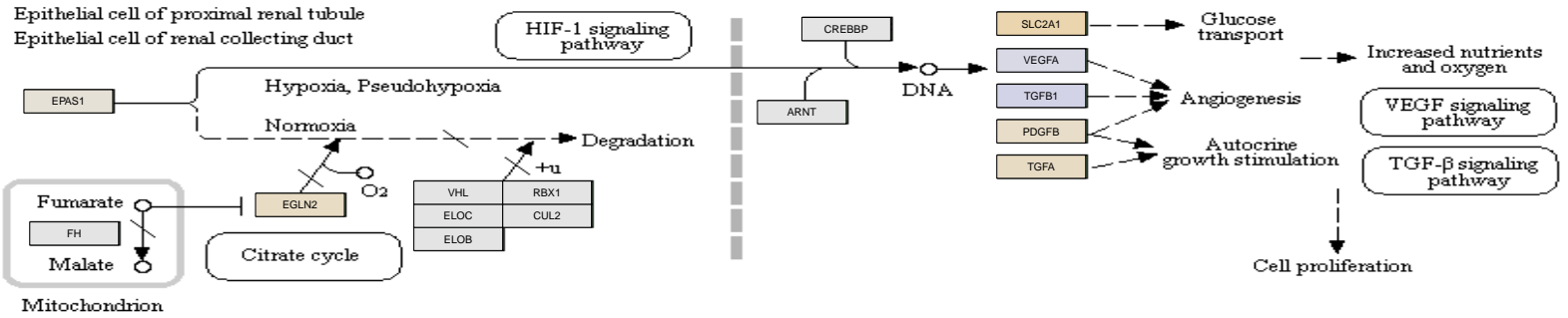

Intercalated cell of renal collecting duct
 ↓
 Oncocytoma

Chromophobe renal carcinoma

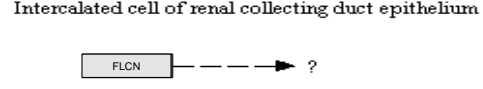

Genetic alterations
 Oncogenes : MET, PRCC-TFE3
 Tumor suppressors : VHL, FH, BHD